

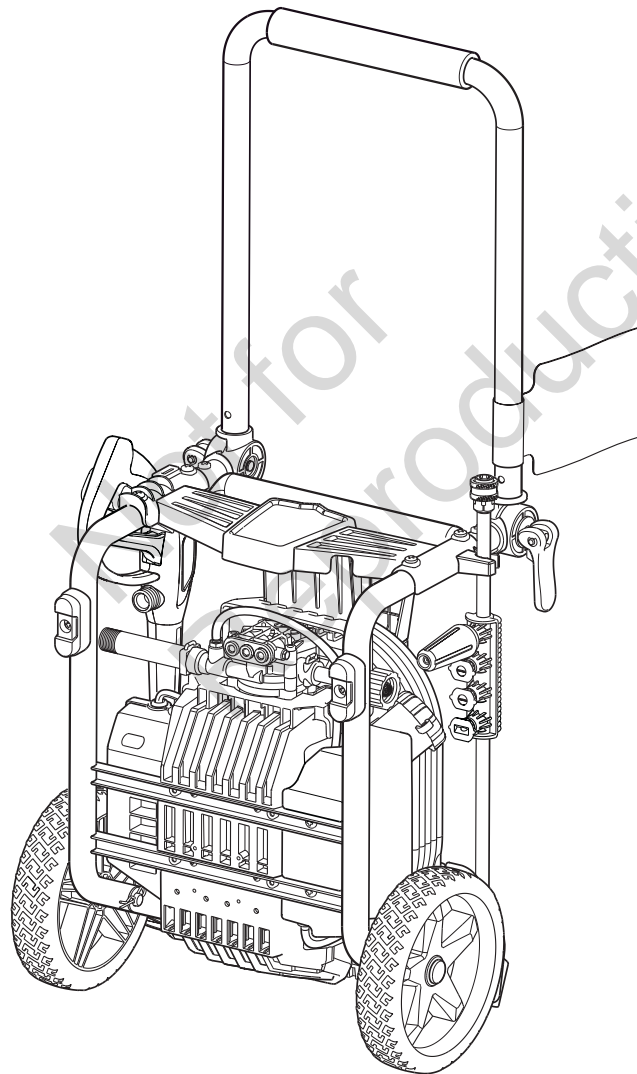

Electric Pressure Washer OPERATOR'S MANUAL



**BRIGGS & STRATTON CORPORATION
MILWAUKEE, WISCONSIN, U.S.A.**

Manual No. 80026125 Revision B

Thank you for purchasing this quality-built Briggs & Stratton® pressure washer. We are pleased that you've placed your confidence in the Briggs & Stratton brand. When operated and maintained according to the instructions in this manual, your Briggs & Stratton pressure washer will provide many years of dependable service.

This manual contains safety information to make you aware of the hazards and risks associated with pressure washers and how to avoid them. Because Briggs & Stratton does not necessarily know all the applications this pressure washer could be used for, it is important that you read and understand these instructions thoroughly before attempting to start or operate this equipment. **Save these original instructions for future reference.**

This pressure washer requires final assembly before use. Refer to the *Assembly* section of this manual for instructions on final assembly procedures. Follow the instructions completely.

Where to Find Us

You never have to look far to find Briggs & Stratton support and service for your pressure washer. There are thousands of Briggs & Stratton authorized service dealers worldwide who provide quality service. You can also contact Briggs & Stratton Customer Service by phone at **1800-356-632 (AUS) or 0800-484-282 (NZ)**, or on the Internet at BRIGGSandSTRATTON.com.au.

Pressure Washer

Model Number _____

Revision _____

Serial Number _____

Date Purchased _____

Table of Contents

Operator Safety	3
Assembly	5
Features and Controls	8
Operation	9
Maintenance	12
Troubleshooting	14
Warranty	15
Product Specifications	16

Operator Safety

Equipment Description

 **Read this manual carefully and become familiar with your pressure washer. Know its applications, its limitations, and any hazards involved.**

This electric pressure washer operates at a maximum of 2,000 PSI (13.8 MPa or 138 BAR) with yellow spray tip and a flow rate of up to 5.3 LPM (1.4 GPM) with detergent spray tip.

This machine is not intended for use by persons (including children) with reduced physical, sensory or mental capabilities, or lack of experience and knowledge.

Every effort has been made to ensure that the information in this manual is accurate and current. However, we reserve the right to change, alter, or otherwise improve the product and this document at any time without prior notice.

NOTICE This equipment is designed to be used with Briggs & Stratton authorized parts **ONLY**.

Portable Residual Current Device Protection

This pressure washer is provided with a portable residual current device (PRCD) built into the power supply cord. This device provides additional protection from the risk of electric shock. The PRCD provides 10 mA of protection. Should replacement of the cord become necessary, use only identical replacement parts that include PRCD protection. Contact a Briggs & Stratton authorized service dealer.

Automatic Shut-Off

The electric pressure washer is equipped with a sensor that will detect that water flow has stopped when releasing or locking the spray gun trigger. The sensor will cause the motor to shut off for as long as the spray gun trigger is released or locked.

If the motor continues to run when the spray gun trigger is released or locked, **DO NOT USE THE MACHINE**. Call the electric pressure washer helpline at **1800-356-632 (AUS)** or **0800-484-282 (NZ)** for assistance.

NOTICE The electric pressure washer is equipped with a main power ON/OFF switch. The switch should always be moved to the OFF position (0) when the electric pressure washer is not being used to prevent possible damage.

Motor Overload

The electric motor in this electric pressure washer is equipped with an overload protection device (thermostat). This device will automatically shut off the motor if the motor overheats or draws excessive current.

If overload protection device is tripped, disconnect power supply by turning master ON/OFF switch to OFF (0) position. Let unit cool for 30 minutes. Then turn master ON/OFF switch to ON (I) position to resume operation.

CAUTION In order to avoid a hazard due to inadvertent resetting of the thermal cut-out, this appliance must not be supplied through an external switching device, such as a timer, or connected to a circuit that is regularly switched on and off by the utility.

Important Safety Information

Safety and Control Symbols

A safety symbol may be used to represent the type of hazard. **WARNING** indicates a hazard which, if not avoided, *could* result in death or serious injury. **CAUTION** indicates a hazard which, if not avoided, *could* result in minor or moderate injury. **NOTICE** indicates information considered important, but not hazard-related.

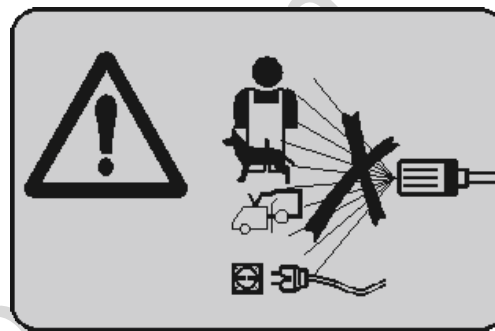

WARNING Risk of electrocution. Contacting both power conductors, at the same time could cause electric shock or burn resulting in death or serious injury.

- Inspect cord before each use, **DO NOT** use if cord is damaged.
- The product is equipped with a portable residual current device (PRCD) built into the power cord. If replacement of the cord is required, use only identical replacement parts.
- Keep all connections dry and off the ground.
- **DO NOT** touch plug with wet hands.
- **DO NOT** run cord through doorways, windows, holes in ceilings, walls, or floors.
- **DO NOT** walk on cord.
- **DO NOT** drive over, drag or place objects over cord.
- **DO NOT** spray near power source or at the unit.

WARNING Risk of fire. Overheated cord could result in death or serious injury.

- Uncoil cord completely prior to use.
- **DO NOT** cover cord with any material.

 **WARNING** Risk of eye or bodily injury. Spray could splash back, propel objects or cause internal harm resulting in serious injury.



- Always wear indirect vented (chemical splash) safety goggles marked to comply with AS/NZS 1337 (ANSI Z87.1 equivalent) when using or in vicinity of this equipment.
- Know how to stop the pressure washer and bleed pressure quickly. Be thoroughly familiar with the controls.
- DO NOT allow CHILDREN or untrained personnel to operate the electric pressure washer.
- Keep operating area clear of all persons.
- Inspect high pressure hose before each use. NEVER repair high pressure hose; replace it.
- DO NOT repair leaking connections with sealant of any kind; replace o-rings and gaskets.
- Keep hose connected to electric pressure washer and spray gun while system is pressurized.
- ALWAYS point spray gun in safe direction while system is pressurized and squeeze spray gun trigger to release high pressure, every time you turn off the pressure washer.
- DO NOT aim spray gun at people or animals.
- DO NOT drink from hose connected accessories.
- DO NOT secure spray gun in open position.
- DO NOT leave spray gun unattended while the electric pressure washer is in ON (I) position.
- Always switch off the master switch when leaving the machine unattended.
- DO NOT use a spray gun which does not have a trigger lock or trigger guard in place and in working order.
- Always be certain spray gun and accessories are correctly attached.
- Stay alert – watch what you are doing.
- DO NOT operate the product when fatigued or under the influence of alcohol or drugs.
- Close supervision is necessary when this product is used near children.

 **WARNING** Risk of fire. Spraying flammable liquids could result in death or serious injury.



- DO NOT spray flammable liquids.

 **WARNING** Use of electric pressure washer could create puddles and slippery surfaces. Risk of kickback. Spray gun could kickback causing you to fall resulting in death or serious injury.



- Operate the electric pressure washer from a stable surface.
- Do not overreach or stand on unstable support. Keep good footing and balance at all times.
- The cleaning area should have adequate slopes and drainage to reduce the possibility of a fall due to slippery surfaces.
- Be extremely careful if you must use the electric pressure washer from a ladder, scaffolding, or any other similar location.
- Firmly grasp spray gun with both hands when using power spray modes to avoid injury when spray gun kicks back.

 **WARNING** Chemical Burn Hazard. Chemicals could cause burns resulting in death or serious injury.



- Always wear indirect vented (chemical splash) safety goggles marked to comply with AS/NZS 1337 (ANSI Z87.1 equivalent) when using or in vicinity of this equipment.
- DO NOT substitute safety glasses or dry-condition goggles for indirect vented safety goggles.
- DO NOT use caustic liquid with electric pressure washer.
- Use ONLY pressure washer safe detergents/soaps. Follow all manufacturers instructions.

 **WARNING** The high pressure stream of water that this equipment produces could cut through skin and its underlying tissues, resulting in serious injury and possible amputation. Spray gun traps high water pressure, even when motor is stopped and water is disconnected, which could result in serious injury.



- NEVER aim spray gun at people, animals, or plants.
- ALWAYS point spray gun in safe direction, squeeze spray gun trigger to release high pressure, every time you turn off pressure washer.
- Do not direct the jet against yourself or others in order to clean clothes or foot-wear.

 **WARNING** Risk of electrocution. Use of an extension cord could cause electric shock or burn resulting in death or serious injury.



- DO NOT use an extension cord with this electric pressure washer. Your home's electrical circuit receptacle or extension cord may not provide lifesaving portable residual current device (PRCD) protection.

NOTICE High pressure spray could damage fragile items including glass.

- DO NOT point spray gun at glass when using turbo spray tip.
- NEVER aim spray gun at plants.

NOTICE You must protect your unit from freezing temperatures.

- Failure to do so will permanently damage your pump and render your unit inoperable.
- Freeze damage is not covered under warranty.

NOTICE Improper treatment of electric pressure washer could damage it and shorten its life.

- If you have questions about intended use, ask dealer or contact authorized service center.
- DO NOT operate units with broken or missing parts, or without protective housing or covers.
- DO NOT by-pass any safety device on the electric pressure washer.
- DO NOT modify the electric pressure washer in any way.
- DO NOT move the electric pressure washer by pulling on hoses. Move unit using the transport handle supplied.
- Use ONLY branded accessories intended for use with this product.

Assembly



Read entire operator's manual before you attempt to assemble or operate your new electric pressure washer.

Your electric pressure washer requires some assembly but is quickly ready for use. If you have any problems with the assembly of your electric pressure washer, please call the electric pressure washer helpline at **1800-356-632 (AUS)** or **0800-484-282 (NZ)**. If calling for assistance, please have the model, revision, and serial number from the identification label available.

Unpack Electric Pressure Washer

1. Remove everything from carton.
2. Raise handle **(A)** to upright position by pulling up latch **(B)** on each side of handle. Push latches down to secure handle in place.

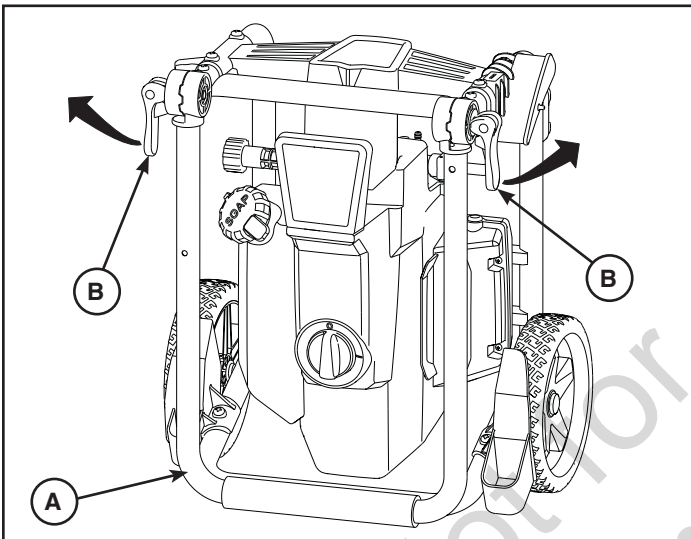

NOTICE The unit is equipped with a foldable handle. The handle can be folded down for storage. See *Final Storage Procedures*.

3. Ensure you have all included items prior to assembly.

Items Included in the Carton

- Main unit
- Operator's Manual
- Spray gun
- High pressure hose
- Spray wand with spray tip holder
- Turbo spray tip
- Quick Connect (QC) spray tips (3)

Become familiar with each component before assembling the electric pressure washer. Identify contents with the illustration shown in *Features and Controls*.

Lubricate O-Rings

Lubrication of o-rings is extremely important for installation and operation. The use of a lubricant (petroleum or synthetic grease) during assembly helps seat o-rings properly and provides an improved seal. It also helps protect the o-ring from damage by abrasion, pinching or cutting and extends the life of the o-ring.

NOTICE ALWAYS apply a small amount of lubricant on o-rings prior to assembling the garden hose to the pump **(C)**, high pressure hose **(D)**, spray gun **(E)** and spray wand **(F)**.

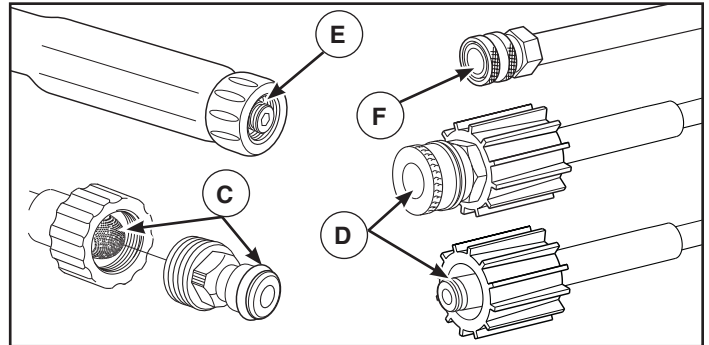

Lubricate all connections shown below, following these instructions:

1. Inspect and clean connecting surfaces prior to lubrication and assembly.
2. Use lubricants sparingly during assembly; a light film is all that is required.
3. Use a small brush or cotton swab to apply grease directly to o-rings where they are not accessible (QC fitting, M22 fitting).

Connect Hose and Water Supply to Pump

NOTICE DO NOT run the pump without the water supply connected and turned on.

- Damage to equipment resulting from failure to follow this instruction will void warranty.
1. Uncoil high pressure hose and attach black end of hose to base of spray gun. Pull back on collar of quick connect, slide fitting onto spray gun and let go of collar. Pull on hose to be sure of a tight connection.

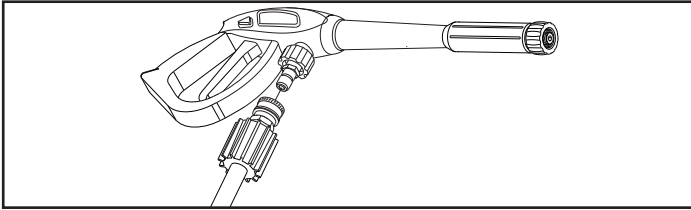

⚠ WARNING The high pressure stream of water that this equipment produces could cut through skin and its underlying tissues, resulting in serious injury and possible amputation.

- NEVER connect high pressure hose to spray wand.
- Keep high pressure hose connected to pump and spray gun while system is pressurized.
- Always be certain spray gun, nozzles and accessories are correctly attached.

2. Attach red end of high pressure hose to high pressure outlet on pump. Tighten by hand.

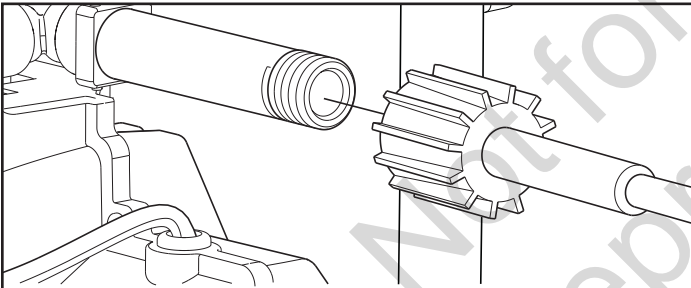

3. Before connecting garden hose to water inlet, inspect inlet screen (A). Clean screen if it contains debris or have it replaced if damaged. DO NOT run pressure washer if inlet screen is damaged.

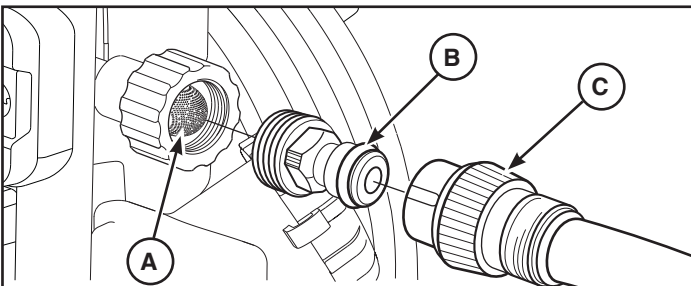

4. Attach garden hose adapter (B) to water inlet. Tighten by hand.
5. Run water through your garden hose (C) for 30 seconds to clean out any debris.

NOTICE DO NOT siphon standing water for the water supply. Use ONLY cold water (less than 38°C (100°F)).



WARNING! Water that has flowed through a backflow preventer is considered to be non-potable.

NOTICE Using a One Way Valve (vacuum breaker or check valve) at pump inlet could cause pump or inlet connector damage.

- There MUST be at least 3 m (10 ft) of unrestricted garden hose between the pressure washer inlet and any device, such as a vacuum breaker or check valve.
 - Damage to equipment resulting from failure to follow this instruction will void warranty.
6. Connect garden hose (not to exceed 15.24 m (50 ft) in length) to water inlet. Pull back on collar of quick connect, slide fitting onto water inlet and let go of collar. Pull on garden hose to be sure of a tight connection.

⚠ WARNING Risk of eye injury.



Spray could splash back or propel objects resulting in serious injury.

- Always wear indirect vented (chemical splash) safety goggles marked to comply with AS/NZS 1337 (ANSI Z87.1 equivalent) when using or in vicinity of this equipment.
- NEVER substitute safety glasses or dry-condition goggles for indirect vented safety goggles.

7. Turn ON the water, press red button (D) on the gun and squeeze the trigger to purge the pump system of air.

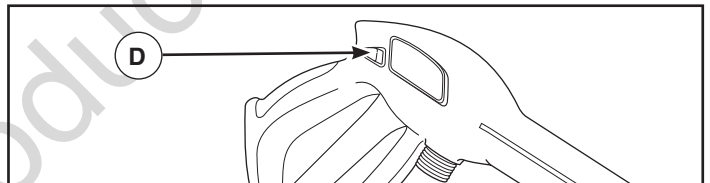

Checklist Before Starting Pump Motor

Review the unit's assembly to ensure you have performed all of the following.

1. Be sure to read *Operator Safety and Operation* before using the electric pressure washer.
2. Check for properly tightened hose connections.
3. Check to make sure there are no kinks, cuts, or damage to hoses.
4. Provide a proper water supply at an adequate flow.
5. Plug electrical power cord into a dedicated electrical circuit rated for 230 Volts AC at 10 Amps that is properly installed in accordance with all local codes and ordinances. Check that circuit is not used to supply any other electrical needs.

Features and Controls



Read the Operator's Manual and safety rules before operating your electric pressure washer.

Compare the illustrations with your electric pressure washer to familiarize yourself with the locations of various controls and adjustments. Save this original manual for future reference.

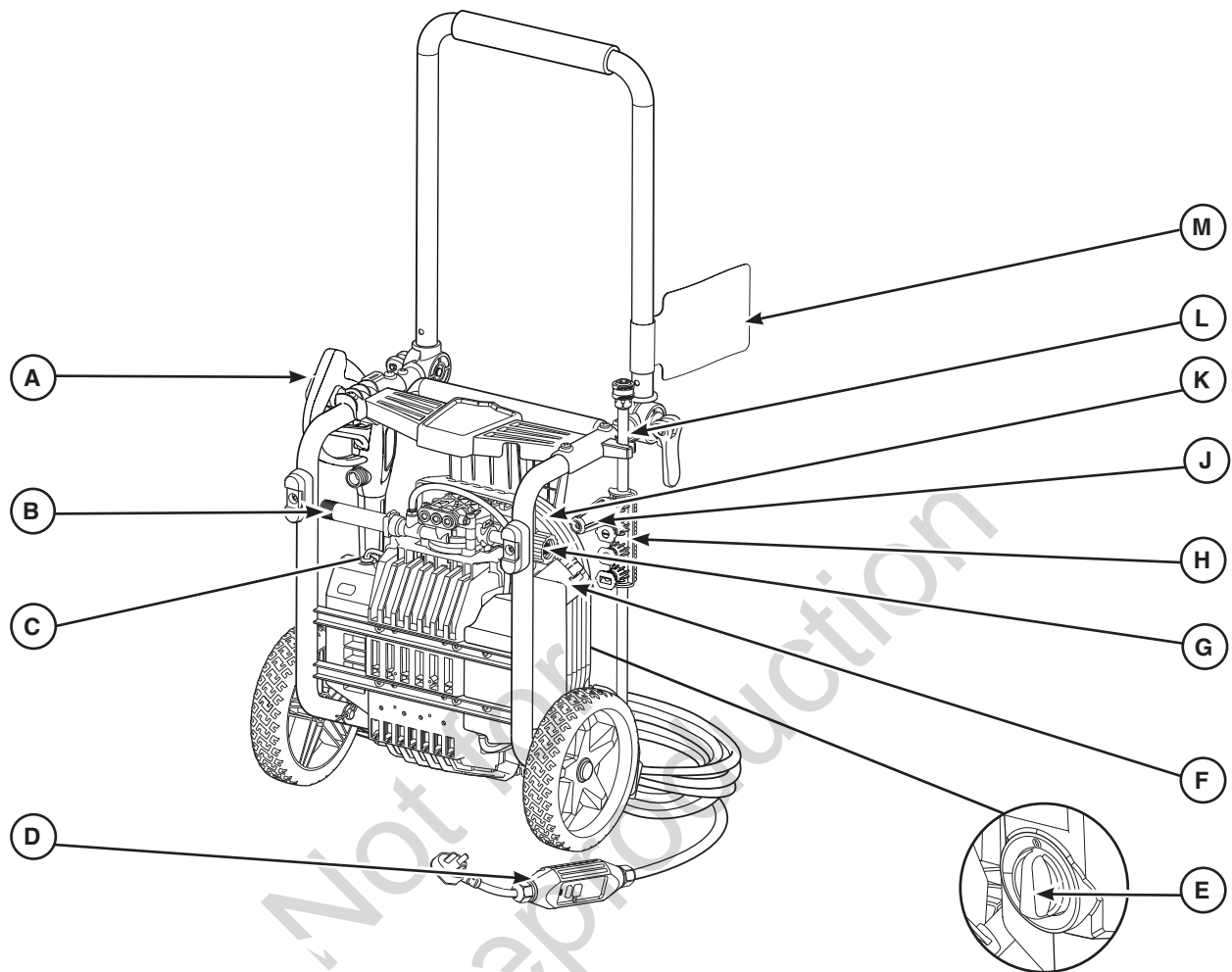

A - Spray Gun — Controls the application of water onto cleaning surface with trigger device. Includes trigger lock.

B - High Pressure Outlet — Connection for high pressure hose.

C - Identification Label — Provides model and serial number of pressure washer. Please have these readily available if calling for assistance.

D - Electric Cord with PRCD — The electric pressure washer and operator is protected by a portable residual current device (PRCD).

E - Master ON/OFF Switch — Turn switch to ON (I) position to start pressure washer. Turn switch to OFF (O) position to stop pressure washer.

F - Detergent Tank — Use to hold up to 1.2 l (40 oz.) of pressure washer safe detergent.

G - Water Supply Inlet — Connect to water supply using a 15.24 m (50 ft.) maximum garden hose.

H - Spray Tips — Detergent, 15°, and 25° for various high pressure cleaning applications.

J - Turbo Spray Tip — Whirls a powerful pin-point jet of water for intense cleaning.

K - High Pressure Hose — Connect red end to high pressure water outlet and black end to spray gun.

L - Spray Wand — Allows you to switch between different spray tips.

M - Warning Label — Identifies hazards to be avoided when using your pressure washer.

Operation

How to Start Your Electric Pressure Washer

Follow the instructions below in the order presented. If you have any problems operating your electric pressure washer, please call the electric pressure washer helpline at **1800-356-632 (AUS)** or **0800-484-282 (NZ)**.

⚠ WARNING Risk of eye injury. Spray could splash back or propel objects resulting in serious injury. Always wear indirect vented (chemical splash) safety goggles marked to comply with AS/NZS 1337 (ANSI Z87.1 equivalent) when using or in vicinity of this equipment.

1. Place pressure washer near an outside water source capable of supplying water at a flow rate greater than 11.4 LPM (3 GPM) and 0.14-0.55 MPa (1.4-5.5 BAR or 20-80 PSI) at pressure washer end of garden hose. **DO NOT** siphon supply water.
2. Check that high pressure hose is tightly connected to spray gun and high pressure outlet. See *Assembly* section.
3. Connect garden hose to water inlet.

NOTICE **DO NOT** run the pump without the water supply connected and turned on.

- Damage to equipment resulting from failure to follow this instruction will void warranty.
4. Turn ON water, point gun in a safe direction, press trigger lock button and squeeze trigger to purge pump system of air.
 5. Place quick connect turbo and colored spray tips in slots on holder attached to spray wand.

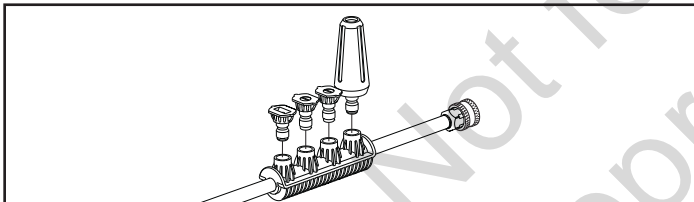

6. Attach spray wand to spray gun. Tighten by hand.

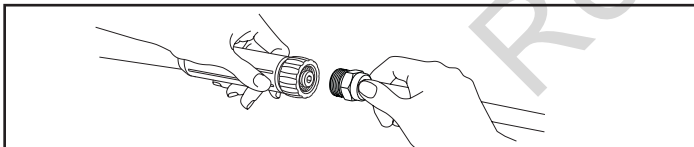

7. Choose spray tip you want to use, pull back on collar of spray wand, insert spray tip and release collar. Tug on spray tip to make sure it is securely in place. See *How to Use Spray Tips*.

NOTICE The unit can be operated in vertical or horizontal positions.

8. Turn master ON/OFF switch (A) to OFF (0) position.

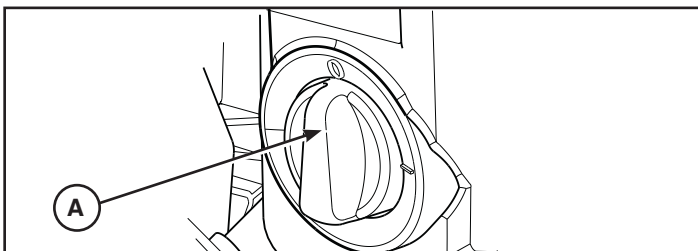

⚠ WARNING Risk of electrocution. Use of an extension cord could cause electric shock or burn resulting in death or serious injury.



- **DO NOT** use an extension cord with this electric pressure washer. Your home's electrical circuit receptacle or extension cord may not provide lifesaving portable residual current device protection (PRCD).

9. Plug electrical power cord into a dedicated electrical circuit rated for 230 Volts AC at 10 Amps that is properly installed in accordance with all local codes and ordinances. Circuit is not to supply any other electrical needs. The indicator light on the PRCD should be ON.

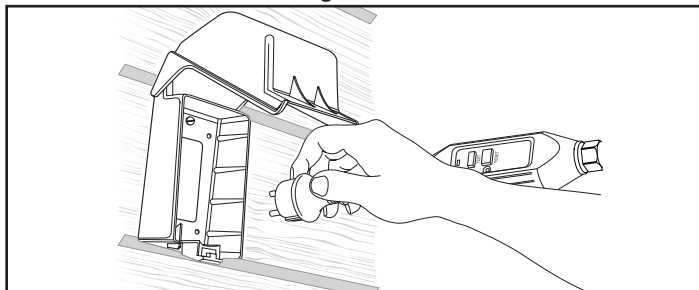

NOTICE The indicator light must be ON for the electric pressure washer to operate.

⚠ WARNING Risk of electrocution. Non-operating PRCD could result in death or bodily injury. If indicator light does not stay ON after test and retest, do not use PRCD.

10. Press TEST button (B). The indicator light (C) should be OFF.

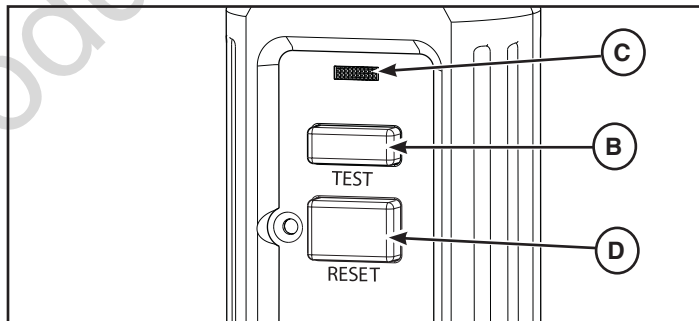

11. Press RESET button (D). The indicator light (C) should be ON.

NOTICE **DO NOT** use the electric pressure washer if above test fails.

12. Turn master ON/OFF switch to ON (I) position.
13. Point gun in a safe direction, press trigger lock button and squeeze trigger.

The electric pressure washer motor will start and stop as spray gun trigger is depressed and released.

The electric pressure washer is now ready for use. Instructions for use of the supplied accessories are given later in this section.

How to Stop Your Electric Pressure Washer

The electric pressure washer motor runs only when the trigger is engaged. To stop the electric pressure washer and turn off the motor:

1. Release spray gun trigger.
2. Turn master ON/OFF switch to OFF (0) position.

NOTICE Releasing the trigger will shut off the motor but does not shut off electrical power to the unit.

3. Turn off water supply.
4. ALWAYS point spray gun in a safe direction, press trigger lock button and squeeze trigger to relieve built up pressure in the unit.

 **WARNING** The high pressure stream of water that this equipment produces could cut through skin and its underlying tissues, resulting in serious injury and possible amputation.

Spray gun traps high water pressure, even when motor is stopped and water is disconnected, which could result in serious injury.

- DO NOT allow CHILDREN to play with or operate pressure washer.
- Keep high pressure hose connected to pump and spray gun while system is pressurized.
- ALWAYS point spray gun in safe direction, squeeze spray gun trigger to release high pressure, every time you turn off pressure washer.

5. Disconnect PRCD plug from outlet.

How to Use Spray Tips

The quick-connect on the spray wand allows you to switch between four different quick connect spray tips. Spray tips can be changed while pressure washer is running once spray gun trigger lock is engaged.

Follow these instructions to change spray tips:

1. Pull back collar on quick-connect and pull current spray tip off. Store spray tips in holder provided on the spray wand.

 **WARNING** The high pressure stream of water that this equipment produces could cut through skin and its underlying tissues, resulting in serious injury and possible amputation.

- NEVER exchange nozzles without the trigger lock being engaged on the spray gun.
- DO NOT twist nozzles while spraying.

2. Select desired spray tip.

- For intense cleaning, whirls a powerful pin-point jet of water, select turbo spray tip.
- For general rinsing, ideal for most all purpose cleaning such as home siding, brick patios, wood decks, driveways and sidewalks, garage floors, etc., select 15° yellow spray tip.
- For gentle cleaning of cars/trucks, boats, RV's, patio furniture, lawn equipment, etc., select 25° green spray tip.
- To apply detergent, applies project specific cleaners to help break down stubborn dirt and grime on a variety of surfaces, select black detergent spray tip.

3. Pull back on collar, insert new spray tip and release collar. Tug on spray tip to make sure it is securely in place.

Usage Tips

- For most effective cleaning, keep spray tip from 20 to 61 cm. (8 to 24 in.) away from cleaning surface.
- If you get spray tip too close, especially using a high pressure spray tip, you may damage surface being cleaned.
- DO NOT get closer than 15.24 cm (6 in.) when cleaning tires.

Applying Detergent

 **WARNING** Chemical Burn Hazard. Chemicals could cause burns resulting in death or serious injury.

- Always wear indirect vented (chemical splash) safety goggles marked to comply with AS/NZS 1337 (ANSI Z87.1 equivalent) when using or in vicinity of this equipment.
- DO NOT substitute safety glasses or dry-condition goggles for indirect vented safety goggles.
- DO NOT use caustic liquid with electric pressure washer.
- Use ONLY pressure washer safe detergents/soaps. Follow all manufacturers instructions.

To apply detergent, follow these steps:

1. Review use of spray tips shown in *How to Use Spray Tips*.
2. Prepare your detergent solution as required by job to be performed.

3. Remove cap from detergent tank and fill with detergent solution. Replace cap.

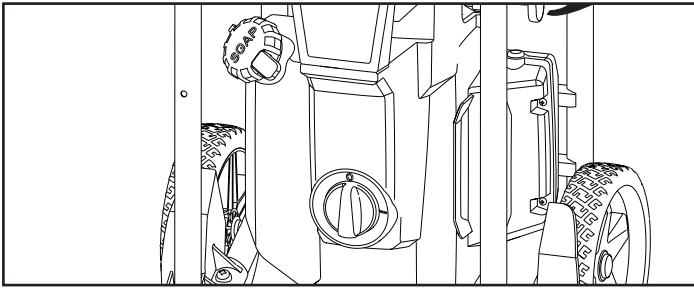

4. Install black detergent spray tip.

NOTICE Detergent cannot be applied with the high pressure spray tips (Turbo, Yellow or Green).

5. Make sure garden hose is connected to water inlet and high pressure hose is connected to spray gun and high pressure outlet. Turn on water.
6. Start the pressure washer as instructed in *How to Start Your Electric Pressure Washer*.
7. Apply detergent to a dry surface, starting at lower portion of area to be washed and work upward using long, even, overlapping strokes.
8. Allow detergent to “soak in” for 3-5 minutes before washing and rinsing. Reapply as needed to prevent surface from drying. To prevent streaking, Do Not allow detergent to dry on surface.

Electric Pressure Washer Rinsing

1. Select desired high pressure spray tip following instructions *How to Use Spray Tips*.
2. Keep spray gun a safe distance from area you plan to spray.

WARNING Risk of kickback.



Spray gun could kickback causing you to fall resulting in death or serious injury.

- Operate the electric pressure washer from a stable surface.
 - Be extremely careful if you must use the electric pressure washer from a ladder, scaffolding, or any other similar location.
 - Firmly grasp spray gun with both hands when using power spray modes to avoid injury when spray gun kicks back.
3. Apply a high pressure spray to a small area and then check surface for damage. If no damage is found, you can assume it is okay to continue rinsing.
 4. Start at top of area to be rinsed, working down with same overlapping strokes as you used for cleaning.

Other Cleaning Tips

- NEVER leave the electric pressure washer unattended while it is plugged into an electrical outlet and while water is supplied to the equipment.
- If you have the spray tip too far away from the surface being washed, the cleaning may not be as effective.

How to Store Accessories

The unit is equipped with areas to store your high pressure hose, spray gun, spray wand, and power cord. Coil power cord and high pressure hose around hook. Store spray gun in the spray gun holder. Store the spray wand in the spray wand holder. Store spray tips in holder provided on the spray wand. Identify all accessories with the illustrations in *Features and Controls*.

Maintenance

General Recommendations

Regular maintenance will improve the performance and extend the life of the electric pressure washer.

The electric pressure washer's warranty does not cover items that have been subjected to operator abuse or negligence. To receive full value from the warranty, the operator must maintain the electric pressure washer as instructed in this manual, including proper storage.

⚠ WARNING To ensure machine safety, use only original spare parts from manufacturer or approved by manufacturer. Should you have questions about replacing components on your electric pressure washer, please visit our website at **BRIGGSandSTRATTON.com.au**.

Remove plug from outlet to disconnect power during cleaning or maintenance and when replacing parts.

Before Each Use

1. Clean debris.
2. Check water inlet screen for debris or damage.
3. Check high pressure hose for leaks.
4. Check spray gun operation.

Electric Pressure Washer Maintenance

Clean Debris

Daily or before use, clean accumulated debris from electric pressure washer. Inspect cooling air slots and openings on the front, rear and bottom of the electric pressure washer. These openings must be kept clean and unobstructed.

The electric pressure washer parts should be kept clean to reduce the risk of overheating and ignition of accumulated debris.

- Use a damp cloth to wipe exterior surfaces clean.

NOTICE Improper treatment of the electric pressure washer can damage it and/or shorten its life.

- DO NOT insert any objects through cooling slots.

Check and Clean Water Inlet Screen

Examine the screen on the unit's water inlet. Clean it if the screen is clogged or replace it if screen is damaged.

Check High Pressure Hose

The high pressure hose can develop leaks from wear, kinking, or abuse. Inspect the hose each time before using it. Check for cuts, leaks, abrasions or bulging of cover, damage or movement of couplings. If any of these conditions exist, replace the hose immediately.

⚠ WARNING The high pressure stream of water that this equipment produces could cut through skin and its underlying tissues, resulting in serious injury and possible amputation.

- NEVER repair high pressure hose. Replace it.
- Replacement hose rating MUST equal or exceed maximum pressure rating of unit.

Check Spray Gun

Examine hose connection to spray gun and make sure it is secure. Test trigger by pressing trigger lock button and making sure trigger "springs back" into place when you release it. You should not be able to press trigger without pressing trigger lock button. Replace spray gun immediately if it fails any of these tests.

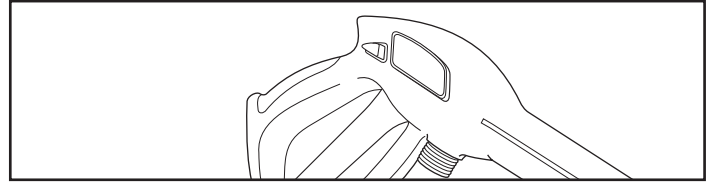

Spray Tip Maintenance

A pulsing sensation felt while squeezing the spray gun trigger may be caused by excessive pump pressure. The principal cause of excessive pump pressure is a clogged spray tip or restricted with foreign materials, such as dirt, etc. To correct the problem, immediately clean the spray tip following these instructions:

1. Press the master ON/OFF switch to the OFF (0) position. Remove power cord plug from electrical outlet.
2. Disconnect water supply at the electric pressure washer.
3. ALWAYS point spray gun in a safe direction, press trigger lock button and squeeze spray gun trigger to release retained high water pressure.

⚠ WARNING The high pressure stream of water that this equipment produces could cut through skin and its underlying tissues, resulting in serious injury and possible amputation.

Spray gun traps high water pressure, even when motor is stopped and water is disconnected, which could result in serious injury.

- DO NOT allow children to play with or operate pressure washer.
- Keep high pressure hose connected to pump and spray gun while system is pressurized.
- ALWAYS point spray gun in safe direction, squeeze spray gun trigger to release high pressure, every time you turn off pressure washer.

3. Remove spray tip (A) from end of spray wand.

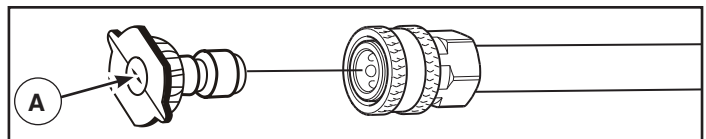

4. Use a small paper clip to free any foreign material clogging or restricting spray tip.
5. Remove spray wand from spray gun.

- Using a garden hose, remove additional debris by back flushing water through spray wand. Back flush between 30 to 60 seconds.

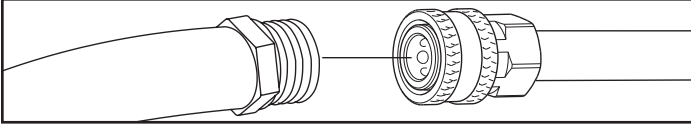

- Reinstall spray tip into spray wand.
- Reconnect spray wand to spray gun.
- Make sure garden hose is connected to water inlet. Check that high pressure hose is connected to spray gun and pump. Turn on water.
- Plug power cord into electrical outlet and turn the master ON/OFF switch to the pressure washer ON (I) position.
- Test pressure washer by operating with each quick connect spray tip.

Pump and Motor Maintenance

The electric pressure washer does not require any maintenance to the pump or motor. Both assemblies are pre-lubricated and sealed, requiring no additional lubrication ever.

After Each Use

Water should not remain in the unit for long periods of time. Sediments or minerals can deposit on pump parts and “freeze” pump action. Follow these procedures after every use:

- To ensure detergent tank does not drain during storage, run electric pressure washer with soap spray tip until tank is empty.
- Add 0.5 liter of clean fresh water to detergent tank, run electric pressure washer with the black detergent spray tip. Flush for one or two minutes.
- Turn master ON/OFF switch to OFF (0) position. Remove power cord plug from electrical outlet.
- Turn off water supply. Point gun in a safe direction, press trigger lock button and squeeze trigger to relieve trapped pressure.
- Disconnect garden hose from water inlet. Disconnect high pressure hose from spray gun and high pressure outlet.
- Drain water from hose and spray gun, then use a cloth or equivalent to wipe off all exterior surfaces.
- Drain water from pump by tipping unit onto its right side (water inlet facing down) for two minutes. Flip unit over and let rest on high pressure outlet for an additional two minutes.
- Coil power cord and high pressure hose around hook.
- Store spray gun in spray gun holder. Store spray wand in spray wand holder. Store spray tips in holder provided on the spray wand. See *Features and Controls* and *Final Storage Procedures*.

- Store unit in a clean, dry area. The unit can be stored in vertical or horizontal position.

- If storing for more than 30 days see *Winter or Long Term Storage*.

Winter or Long Term Storage

Follow steps 1-9 in *After Each Use*.



NOTICE Water left in pump could freeze and permanently damage pump. Freeze damage is not covered under warranty.

Protecting the Pump

To protect the pump from damage caused by mineral deposits or freezing, use PumpSaver, Model 6039, to treat pump. This prevents freeze damage and lubricates plunger and seals.

NOTICE PumpSaver is available as an optional accessory. It is not included with the electric pressure washer. Contact the nearest authorized service center to purchase Pump Saver.

NOTICE You must protect your unit from freezing temperatures.

- Failure to do so will permanently damage your pump and render your unit inoperable.
- Freeze damage is not covered under warranty.

To use PumpSaver, make sure electric pressure washer is turned off and inlet and outlet hoses are disconnected. Read and follow all instructions and warnings given on the PumpSaver container.

Final Storage Procedures

- Coil power cord and high pressure hose around hook.
- Store spray gun in spray gun holder. Store spray wand in spray wand holder. Store spray tips in holder provided on the spray wand. See *Features and Controls* and *Final Storage Procedures*.
- Store unit in a clean, dry area that is protected from freezing temperatures. The handle can be folded down for storage. The unit can be operated in vertical or horizontal positions.
- Cover unit with a suitable protective cover that does not retain moisture.

Troubleshooting

Problem	Cause	Correction
Pump has following problems: failure to produce pressure, erratic pressure, chattering, loss of pressure, low water volume.	<ol style="list-style-type: none"> 1. Water inlet is blocked. 2. Inadequate water supply. 3. Garden hose is kinked or leaking. 4. Clogged water inlet screen. 5. Water supply is over 38° C (100° F). 6. High pressure hose is blocked or leaks. 7. Spray tip is obstructed. 	<ol style="list-style-type: none"> 1. Clear inlet. 2. Provide adequate water flow. 3. Straighten garden hose or replace if leaking. 4. Check and clean water inlet screen. 5. Provide cooler water supply. 6. Clear blocks in high pressure hose or replace hose. 7. Clean spray tip.
Unit fails to start when spray gun trigger is squeezed.	<ol style="list-style-type: none"> 1. Water supply is not turned on. 2. Unit is not turned on. 3. Garden hose is too long. 4. Fuse blown or circuit breaker tripped. 	<ol style="list-style-type: none"> 1. Turn on water supply. 2. Press the master ON/OFF switch to the ON (I) position. Reset PRCD. 3. Use only 15.24 m (50 ft.) maximum garden hose. 4. <ol style="list-style-type: none"> a.) Check fuse box for blown fuse and replace as necessary or reset circuit breaker. Do not use a fuse or circuit breaker with a higher rating than that specified for your particular branch circuit. b.) Disconnect other electrical appliances and turn off lights in the circuit or operate the pressure washer on its own dedicated circuit. c.) Run pressure washer with any spray tip for 5 minutes. Motor break in may be necessary.
Detergent fails to mix with spray.	<ol style="list-style-type: none"> 1. High pressure spray tip is installed. 2. Inlet water supply pressure too high. 	<ol style="list-style-type: none"> 1. Install black detergent spray tip. 2. Slowly close water supply valve until chemical just starts to draw (soap suds will appear when chemical starts to draw).
Hose connections leaking.	<ol style="list-style-type: none"> 1. Garden hose loose to water inlet. 2. Loose high pressure hose connections. 3. Damaged o-ring. 	<ol style="list-style-type: none"> 1. Hand tighten garden hose to water inlet. 2. Remove hose completely and reinstall hand tight. 3. Replace o-ring.

For all other issues, see a Briggs & Stratton authorized dealer.

LIMITED WARRANTY

Briggs & Stratton warrants that, during the warranty period specified below, it will repair or replace, free of charge, any part that is defective in material or workmanship or both. Transportation charges on product submitted for repair or replacement under this warranty must be borne by purchaser. This warranty is effective for and is subject to the time periods and conditions stated below. For warranty service, find the nearest Authorized Service Dealer in our dealer locator map at BRIGGSandSTRATTON.COM The purchaser must contact the Authorized Service Dealer, and then make the product available to the Authorized Service Dealer for inspection and testing.

There is no other express warranty. Implied warranties, including those of merchantability and fitness for a particular purpose, are limited to the warranty period listed below, or to the extent permitted by law. Liability for incidental or consequential damages are excluded to the extent exclusion is permitted by law. Some states or countries do not allow limitations on how long an implied warranty lasts, and some states or countries do not allow the exclusion or limitation of incidental or consequential damages, so the above limitation and exclusion may not apply to you. This warranty gives you specific legal rights and you may also have other rights which vary from state to state or country to country.**

WARRANTY PERIOD

Consumer Use	Commercial Use
24 months	None

** In Australia - Our goods come with guarantees that cannot be excluded under the Australian Consumer Law. You are entitled to a replacement or refund for a major failure and for compensation for any other reasonably foreseeable loss or damage. You are also entitled to have the goods repaired or replaced if the goods fail to be of acceptable quality and the failure does not amount to a major failure. For warranty service, find the nearest Authorized Service Dealer in our dealer locator map at BRIGGSandSTRATTON.COM, or by calling 1300 274 447, or by emailing or writing to salesenquires@briggsandstratton.com.au, Briggs & Stratton Australia Pty Ltd, 1 Moorebank Avenue, NSW, Australia, 2170.

The warranty period begins on the date of purchase by the first retail or commercial consumer. "Consumer use" means personal residential household use by a retail consumer. "Commercial use" means all other uses, including use for commercial, income producing or rental purposes. Once a product has experienced commercial use, it shall thereafter be considered as a commercial use product for purposes of this warranty.

Save your proof of purchase receipt. If you do not provide proof of the initial purchase date at the time warranty service is requested, the manufacturing date of the product will be used to determine the warranty period. Product registration is not required to obtain warranty service on Briggs & Stratton products.

ABOUT YOUR WARRANTY

Warranty service is available only through Briggs & Stratton Authorized Service Dealers. Most warranty repairs are handled routinely, but sometimes requests for warranty service may not be appropriate. This warranty covers only defects in materials or workmanship. It does not cover damage caused by improper use or abuse, improper maintenance or repair, normal wear and tear, or stale or unapproved fuel.

Improper Use and Abuse - The proper, intended use of this product is described in the Operator's Manual. Using the product in a way not described in the Operator's Manual or using the product after it has been damaged will not be covered under this warranty. Warranty coverage will also not be provided if the serial number on the product has been removed or the product has been altered or modified in any way, or if the product has evidence of abuse such as impact damage or water/chemical corrosion damage.

Improper Maintenance or Repair - This product must be maintained according to the procedures and schedules provided in the Operator's Manual, and serviced or repaired using genuine Briggs & Stratton parts or equivalent. Damage caused by lack of maintenance or use of non-original parts is not covered by warranty.

Normal Wear and Tear - Like most mechanical devices, your unit is subject to wear even when properly maintained. This warranty does not cover repairs when normal use has exhausted the life of a part or the equipment. Maintenance and wear items such as filters, belts, cutting blades, and brake pads (except engine brake pads) are not covered by warranty due to wear characteristics alone, unless the cause is due to defects in material or workmanship.

Stale or Unapproved Fuel - In order to function correctly, this product requires fresh fuel that conforms to the criteria specified in the Operator's Manual. Engine or equipment damage caused by stale fuel or the use of unapproved fuels (such as E15 or E85 ethanol blends) is not covered by warranty.

Other Exclusions - This warranty excludes damage due to accident, abuse, modifications, alterations, improper servicing, freezing or chemical deterioration.

Attachments or accessories that were not originally packaged with the product are also excluded. There is no warranty coverage on equipment used for primary power in place of utility power or on equipment used in life support applications. This warranty does not include used, reconditioned, second-hand, or demonstration equipment or engines. This warranty also excludes failures due to acts of God and other force majeure events beyond the manufacturer's control.

80026311_EN Rev A

Not for
Reproduction



Electric Pressure Washer

Specifications

Allowable Pressure	PSI/MPa/BAR	2,500/17.2/172*
Max Flow	LPM/GPM	5.3/1.4*
Rated Pressure and Flow	PSI/MPa/BAR @ LPM/GPM	2,000/13.8/138 @ 4.1/1.1*
Water Supply Temperature	°C/°F	5-38/41-100
Rated Voltage	V	230
Rated Frequency	Hz	50
Power Consumption	W	1,380
Current	A	6
Protection Class	Class	Class I
Protection Degree	IP xx	IPX5
Sound Pressure Level L_{pA} at 3m	dB(A)	80 [§]

* Per AS/NZS 60335-2-79

§ Measured sound values in accordance to Tasmanian Environmental Management and Pollution Control (Miscellaneous Noise) Regulations.

Briggs & Stratton Corporation
P.O. Box 702
Milwaukee, Wisconsin, 53201-0702 U.S.A.